

## USER DRIVEN MANUAL\*

Any feedback, changes, or advice we are glad to hear it. Please contact us at [support@estateswing.com](mailto:support@estateswing.com)

## —WARNING—

Read all instructions before beginning installation or use of this gate opener. This operator exerts a high level of force. Exercise caution at all times and stay clear of the system during operation.

# Estate SLIDIE



## E-SL 450BD Series

# INSTRUCTION MANUAL

*\*Estate Swing's unique user driven manuals are constantly updated by installers and homeowners like yourself. We improve by hearing and applying your feedback.*

# Estate Swing Summary of Functions

## Estate Slide Summary of Functions

**The Estate Slide is only to be used for vehicular Slide gates in a Class I setting.**

**Class I:** A vehicular gate opener (or system) intended for use in a home of one-to-four single family dwelling, or a garage or parking area associated therewith.

The Estate Slide automated system was designed and built for controlling vehicle access. Do not use for any other purpose.

The Estate Slide automated system automates residential Slide-leaf gates with leaves of up to 18' in length.

It consists of a locking electro-mechanical linear operator, powered by a 24V AC transformer, coupled with control board that switches the voltage to DC to power the motor. The MASTER card can be programmed and is used to set the following: function logics, work times (by self-learning) and pause times, leaf speed, and the sensitivity of the anti-crushing device.

The locking system will automatically lock when the motor is not operating. A release system enables the gate to be moved by hand in case of a system failure.

## For Your Assistance

Keep this manual safely stored after installation

Serial Number \_\_\_\_\_

Date of Purchase \_\_\_\_\_

Place of Purchase \_\_\_\_\_

Have this information on hand while handling all service and warranty issues.

# Specifications & Part List

|                                      |                           |
|--------------------------------------|---------------------------|
| <b>Model</b>                         | <b>Estate Slide 450BD</b> |
| <b>Power Supply</b>                  | 24 V AC / 24V DC          |
| <b>Absorbed Power (W)</b>            | 50                        |
| <b>Absorbed Current (Amps)</b>       | 10                        |
| <b>Max Run Time</b>                  | 5.6 Minutes               |
| <b>Operating Ambient Temperature</b> | -4 °F to +124 °F          |
| <b>Motor Rotational Speed</b>        | 2000r / min               |
| <b>Gate Leaf Max Length (ft.)</b>    | Up to 14                  |
| <b>Gate Leaf Max Weight (lbs.)</b>   | Up to 450                 |
| <b>Type of Limit Switch</b>          | Magnetic                  |

## Estate Swing Parts Included:

- A) Two Remotes
- B) Transformer
- C) Limit Magnet
- D) Release Keys
- E) Battery
- F) Belt
- G) Motor

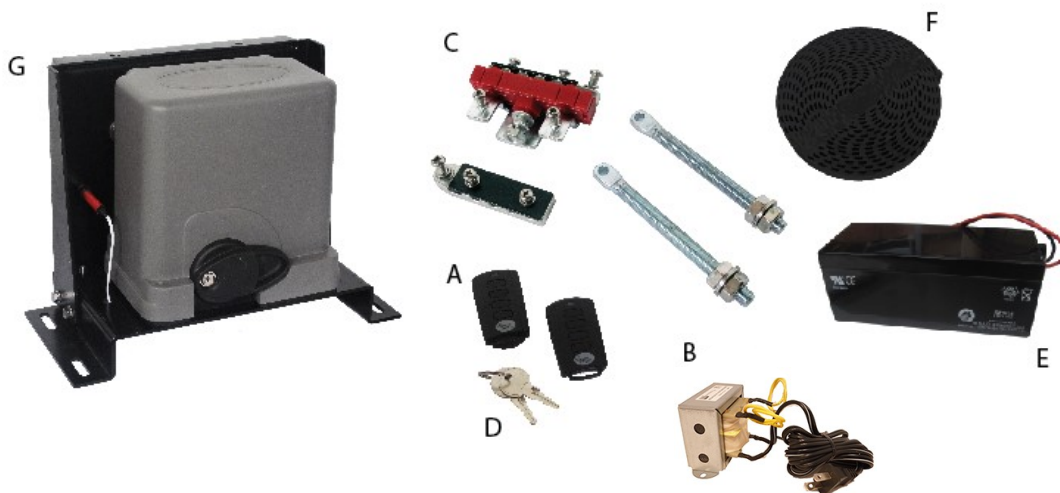

## Standard System Overview and Safety Zones

The system display below is a recommended standard system. Other approved accessories can be installed.

Photo sensors and a flashing light indicating gate movement is recommended for safety purposes.

**1) Estate Slide Operator 2) Photocells (not included) 3) Key operated pushbutton (not included) 4) Flashing lamp (not included) 5) Radio receiver (optional)**

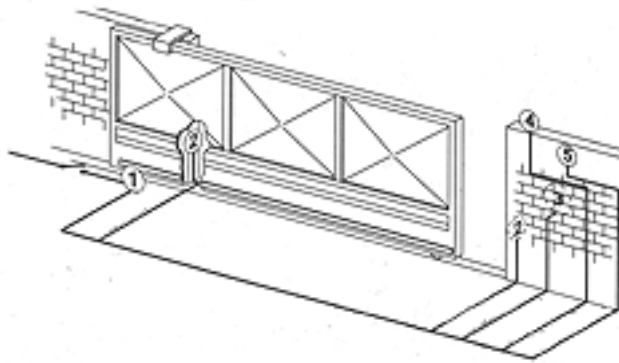

### NOTES:

- 1) Do not extend operator connection cables
- 2) When laying electrical cables, use appropriate rigid and/or flexible tube
- 3) Do not run any wires in the same conduit as 110 AC power that may be in the area. This will cause unwanted interference

## Important Preliminary Checks:

To ensure safety and an efficiently operating automated system, make sure the following conditions are observed.

- The gate and post must be suitable for being automated. Check that the structure is sufficiently strong and rigid, and its dimensions and weights conform to those indicated in section 1. In particular, wheel diameter must be in relation to the weight of the gate to be automated. Dimensions and weight must match those indicated in the technical specifications.
- Make sure the leaves move smoothly without any irregular friction during entire travel.
- The soil must permit sufficient stability for the expansion plugs securing the foundation plate.
- Check if the upper guide and travel limit mechanical stops are installed.

We advise you to have any metalwork carried out before the automated system is installed.

## Tools Needed For Installation



- Power Drill
- Crescent Wrench
- Metal Drill Bits
- Hacksaw
- Flat Head Screwdriver
- Phillips Head Screwdriver
- Tape Measure
- Level
- Wire Strippers
- C-clamps

### Other items that may be needed prior to commencing installation:

- Cement, boards for a slab frame, and a trowel.
- Low voltage wire will be required to run power to your operator. See the power page for specifications.
- If the gate is more than 144' from an a/c power supply then an electrician will be required to move a supply closer.
- Depending on the current base, you may need cement to form a level mounting pad.
- A voltage meter may be necessary to run diagnostic checks.
- A digital camera will come in handy with technicians if any support is needed.

# Manual Operation

1. Key release the lever.
2. Lift the lever to disengage the gears.
3. The motor will not run again until the motor is relocked. There is a magnetic sensor that allows the motor to operate, be sure the magnet is lined up with the sensor.

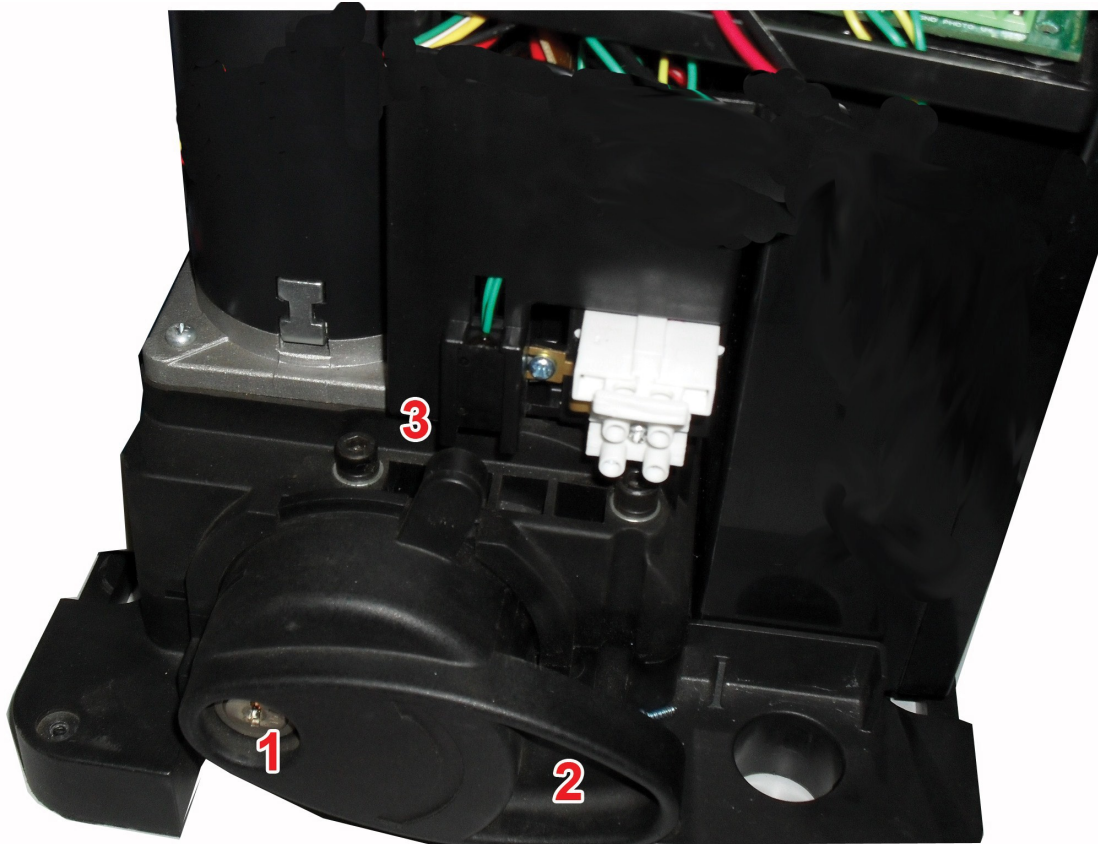

# Creating Mounting Slab

1. Determine the height of your concrete pad based upon how high the gate is from the ground and where the belt can be mounted to the gate. The minimum height from the top of the slab to the belt is 10".
2. Pour a concrete pad for your opener to bolt to. Levelness of the pad is important. For convenience place a piece of conduit that runs up the center of the pad and the other end is easily accessible.
3. After the foundation has dried, use 7/16 concrete anchors attach the opener to the base.

**NOTE: The gate opener can be placed on the left or right of the driveway. The diagram below is for being placed on the left side of the driveway (if you are standing on the inside of the property looking out)**

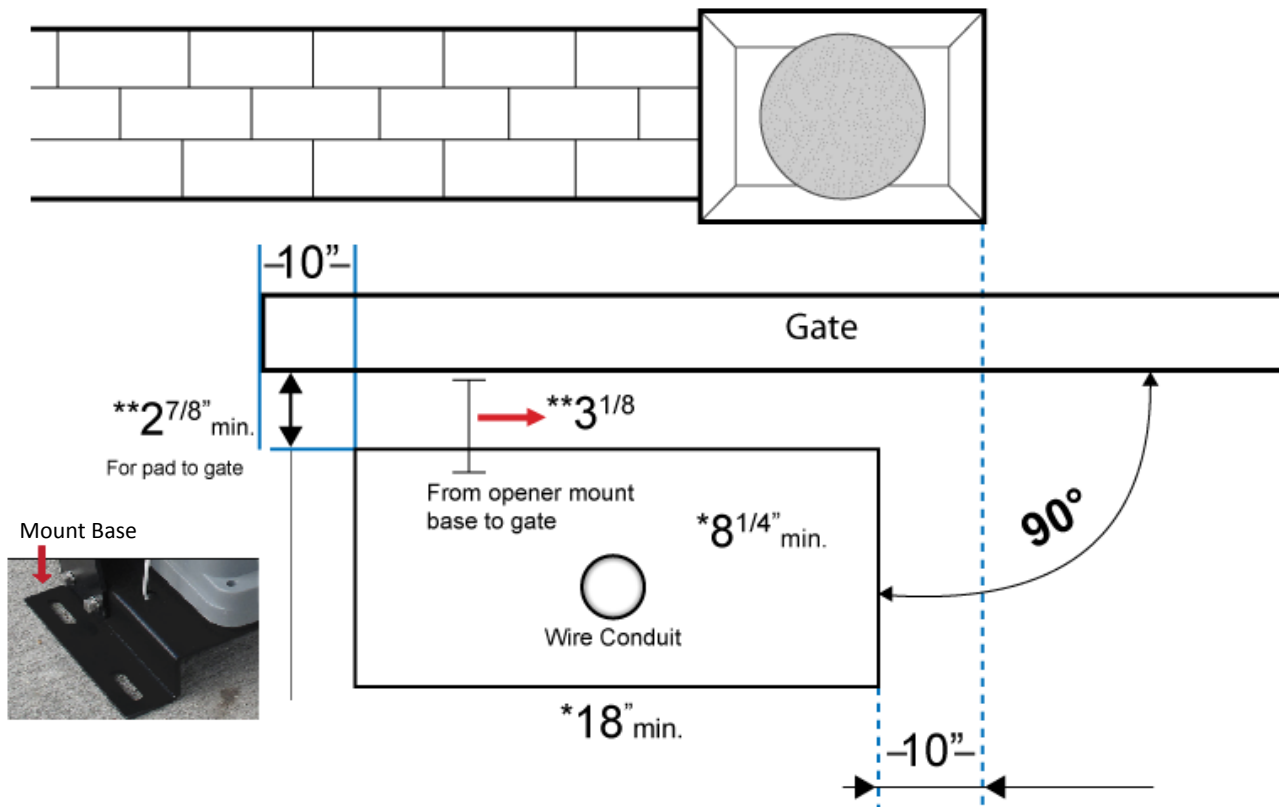

\* Pad can be larger/closer to gate as long as opener is mounted at correct distance from the gate.

\*\* Dimension can be greater if spacers are used to offset gate brackets from rear face of gate. Spacers will need to be  $(\text{Base distance from gate}) - 3\frac{1}{8} = \text{Spacer Width}$ .

Concrete Slab Tips: Creating a wood rectangle with no top is a good way to form a slab. After the cement dries the wood can be knocked away. The slab must be secured to the ground below. Having rebar pass into the slab works well.

## Securing the Operator

If the height of the operator from the slab ever has to be adjusted, nuts can be inserted just on the threads between the anchor and the bottom of the opener—the opener can be moved up the threading and the operator can rest on the nuts.

Feed any wires up through the opener while installing the opener to the base.





## Installation of Motor

**Horizontal position of gate bracket:** The hole in the gate bracket should be mounted on the gate so it is centered with the idler gears horizontally. Depending on how close you mounted the gate opener from the rear face of the gate you may need to shim your bracket to make it protrude off the back of the gate more to achieve this.

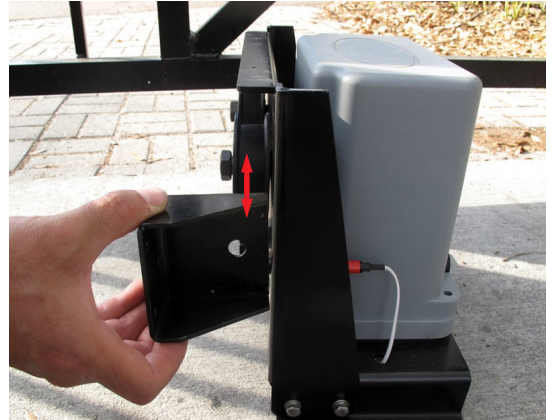

**Vertical position of gate bracket:** The hole in the gate bracket should be level with the top of the idler gears when mounted on the gate.

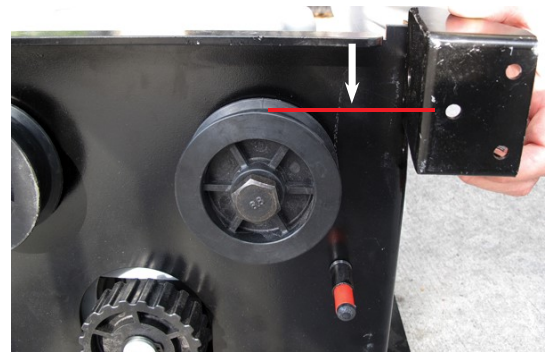

After identifying the correct height for the gate bracket, bolt the bracket to your gate frame using the three mounting holes. The flat side with a single hole should be facing in toward the center of the gate.



On one side of the gate lay the belt into the belt attachment bracket so the teeth of the belt mesh the teeth of the bracket.



## Installation of Motor

Lay the top of the belt bracket on the belt. It has two holes in it. Mark and drill two holes in the belt. Then put the bolts through the bolt bracket assembly to hold the bracket to the belt.



Attach the assembled belt bracket to the belt attachment bolt.

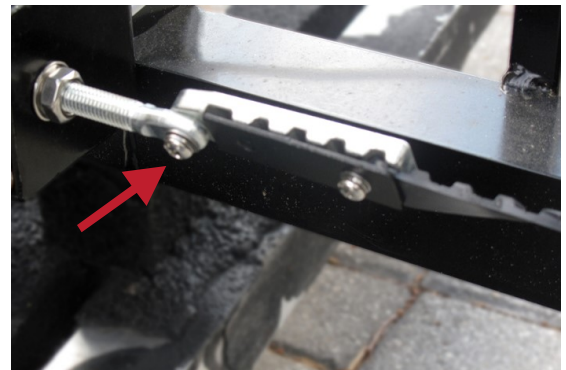

Run the belt over the idlers and under the mechanized gear with the belt teeth facing up.

Repeat gate bracket and belt bracket steps on the other side of the gate to attach the other end of the belt to the gate. The belt may need to be cut down to be tight if you gate is not 15 feet long including tail. Do not cut the belt until you have run the belt through the gears to account for the length needed for this.



Make your final tightening adjustments on the belt. The belt should not have excessive sag in it (no more than 2 inch variance from furthest bracket to opener). To tighten the belt after mounting, move the nuts on the belt attachment bolt.



## Installation of Motor

Find the correct height for the limit magnet to find the mounting spot from the gate. This should be done in conjunction with the next step of adjusting the horizontal distance the limit switch protrudes from the side of the unit. The distance from the limit magnet to the limit switch should be under 1 inch.

Adjust the limit switch horizontally to match up with the limit magnet. The distance between the two should not exceed 1 inch.

Mount your limit magnet on the provided piece of flat bar. The flat bar is intended to be attached to your gate at the correct height to trigger your limit switch in the gate's **OPEN** position. There are many ways to attach the flat bar to your gate so the bar is left un-drilled and unpainted for best suiting it to your style gate.

**Example:** In the photo the gate is picket style, in this case we would use self tapping metal screws to attach the bar to the pickets. Then we would paint the flat bar black.

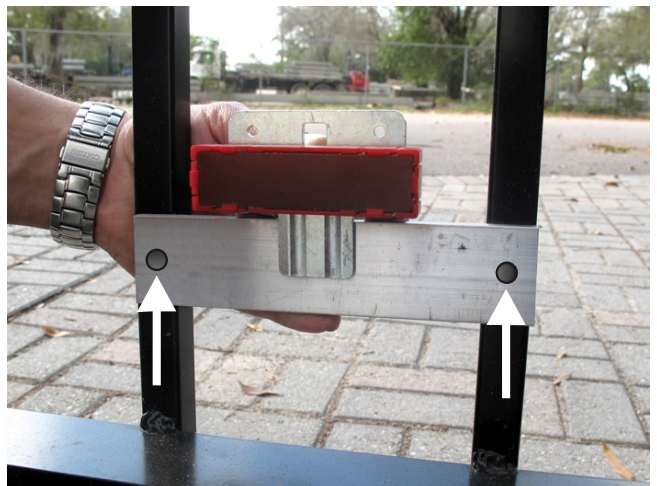
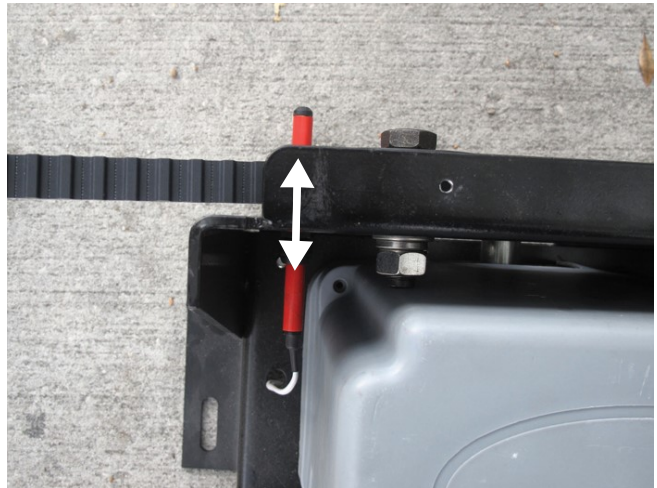

## Auto Reclose, Left / Right Mode, Force

Dip switches and auto-reclose time must be set with both transformer and battery power off to take effect.

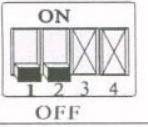
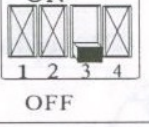
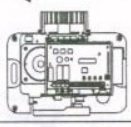
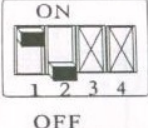
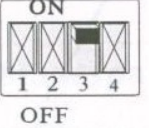
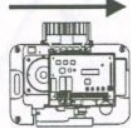
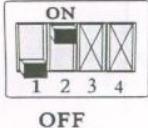
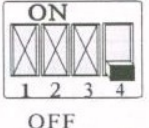
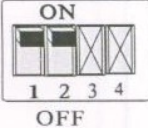
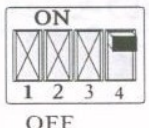
|   |  |   |  |
|---|--|---|--|
|  | <h3>Force Level 1</h3> <p>Obstructs with least amount of force</p> |  |  <p>Opens Left</p>  |
|  | <h3>Force Level 2</h3>   |  |  <p>Opens Right</p> |
|  | <h3>Force Level 3</h3>   |  | <p>Auto-Reclose OFF</p>  |
|  | <h3>Force Level 4</h3> <p>Obstructs with most amount of force</p>  |  | <p>Auto-Reclose ON</p>   |

The force of the motor is adjustable - Lowest means it will obstruct easier, highest means it will exert more force on an object before obstructing.

**Motor Side:** Left indicates the motor is mounted on the left hand side of the driveway, right is if the motor is on the right side of the driveway.

The side is determined if you are standing on the outside of the property looking in facing the opener.

The gate can be set to automatically reclose after a certain period of time or work like a garage door opener; where it goes open and stays open until you press your remote to reclose it (OFF).

*If auto reclose is on from the chart above adjust the time on the potentiometer (seen below)*

*Clockwise is a longer pause time.*

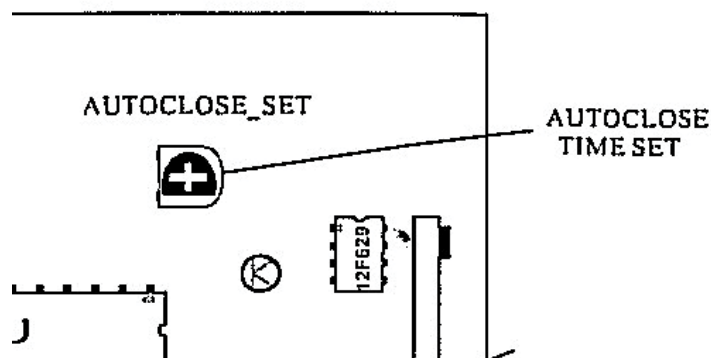

## DIY Power Connection

1. The provided 24V DC battery is for back up, connect it to the pre-wired connector on the board before plugging in your transformer.
2. The Estate Swing E-SL 450BD comes with 1) 24V transformer. The transformer supplied has 2 yellow wires to be spliced to low voltage wire . You may extend those wires and locate the transformer up to **400' away from the control board using 2 conductor stranded 16 gauge direct burial wire**. The transformer must be kept in a weather protected area and also in a location that it cannot be tampered with by children or pets. It is be.
3. Connect the two wires from the transformer on the top and bottom screw terminals on the white connector on the side of the gate opener.
4. Plug the **transformer** into a 120 VAC outlet.

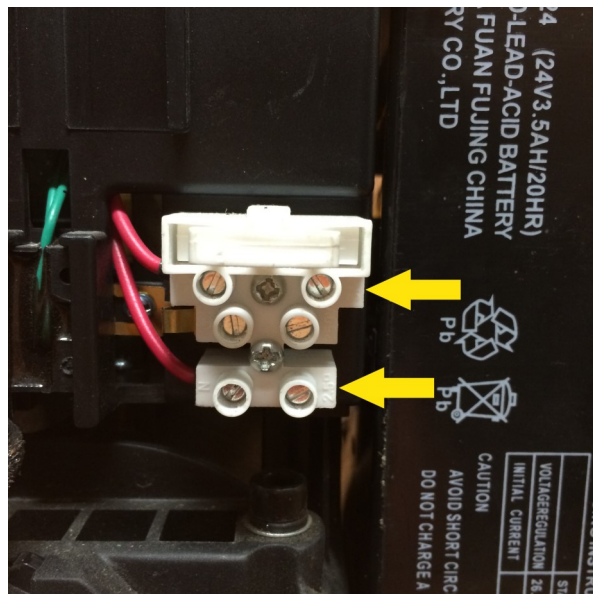

**Never run 110VAC power directly to the Estate Swing. This will destroy the Estate Swing control board. Never connect the power wire with the transformer plugged in. Contact between the two lead wires, even for a second, will destroy the transformer.**

Transformers are only warranted if the internal fuse is not blown. If the fuse is blown an outside factor (shorting, surge, water, etc) has caused the transformer not to function.

# Temporary Safety Jumpers

For the highest level of safety, the Estate Swing systems are set up with Normally Closed safety terminals. This means that in order for the gate opener to move these terminals must be closed either through a safety device (recommended) or with jumpers. Temporary safety jumpers are installed in the factory

It is recommended not to use any accessories until setup and programming is complete.

**NOTE:** If not using safety devices the temporary safety jumper must remain in. In order for the gate operator to move. Also in order for safety devices to function the safety jumpers must be removed.

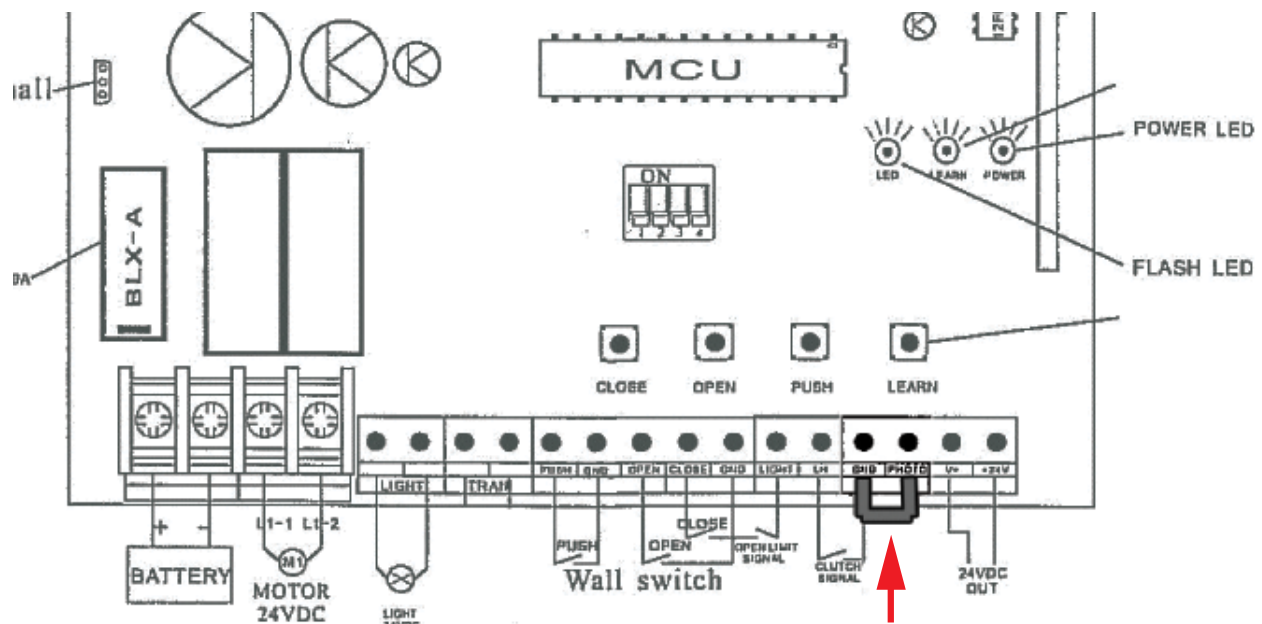

## Troubleshooting Tip:

If the gate will only open and will not close - the safety jumper is not making a connection between the two terminals. Even with a jumper in place, sometimes metal or wire loses its conductivity for various reasons. Please try to replace this jumper and see if the problem is resolved.

## Learning Closed Position

In this stage, your control board will memorize run time and where to stop in the closed position.

Manually release and close the gate; then lock it into gear. This position should be where you want the gate to stop every time.

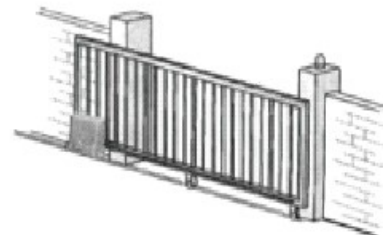

Using a screwdriver jump the pins on the lower right of the board marked **SET**. LED1 will flash and the buzzer will beep 3 times.

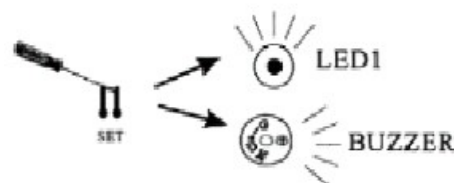

Press the OPEN button. The gate will go open and stop on the limit magnet.

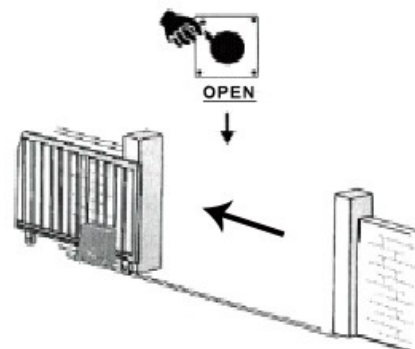

The gate will then move closed, stopping in the original closed position and then go back open again as a test cycle. Programming is now done.

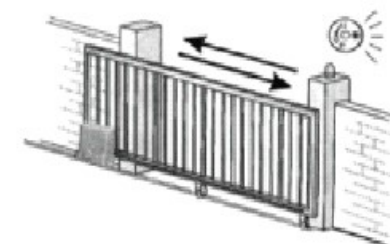

**Note: If your gate moves further closed instead of open: the motor side is incorrect.**

- Remove battery and transformer power.
- Change dip switch number 3 to the opposite position it is currently on.
- Reapply power and begin programming again.

# Setting Transmitters

## Receiver

The receiver is built into the board. It can have up to 6 remotes programmed into the system. It has two types of openings that can be programmed in - Full Open/Close and Pedestrian Open. Full opening is normal operation of the gate. Pedestrian opening will partially open the gate and stop. The gate can then be closed again by using the full open/close.

**Warning: gate opener may run immediately when programming is finished - do not program transmitters before programming run time.**

### Programming Full Open / Close Button:

1. Choose a button on the remote.
2. Press the LEARN button and the LEARN LED will light up.
3. Press and hold the button you have chosen for Full Open / Close on a remote until the LEARN LED light goes out.
4. Repeat with other remotes.

### Programming Pedestrian Open Button:

1. Choose a button on the remote.
2. Press the LEARN button TWICE and the LEARN LED will flash twice and then light up.
3. Press and hold the button you have chosen for Full Open / Close on a remote until the LEARN LED light goes out.
4. Repeat with other remotes.

**Erasing All Transmitters:** Press and hold LEARN button until the LEARN LED flashes. You will then have to reprogram all remotes back in.





# Control Board Overview



**Caution! Do not run 120V AC power direct to the board. This will cause permanent damage to both boards and void your warranty. Caution!**

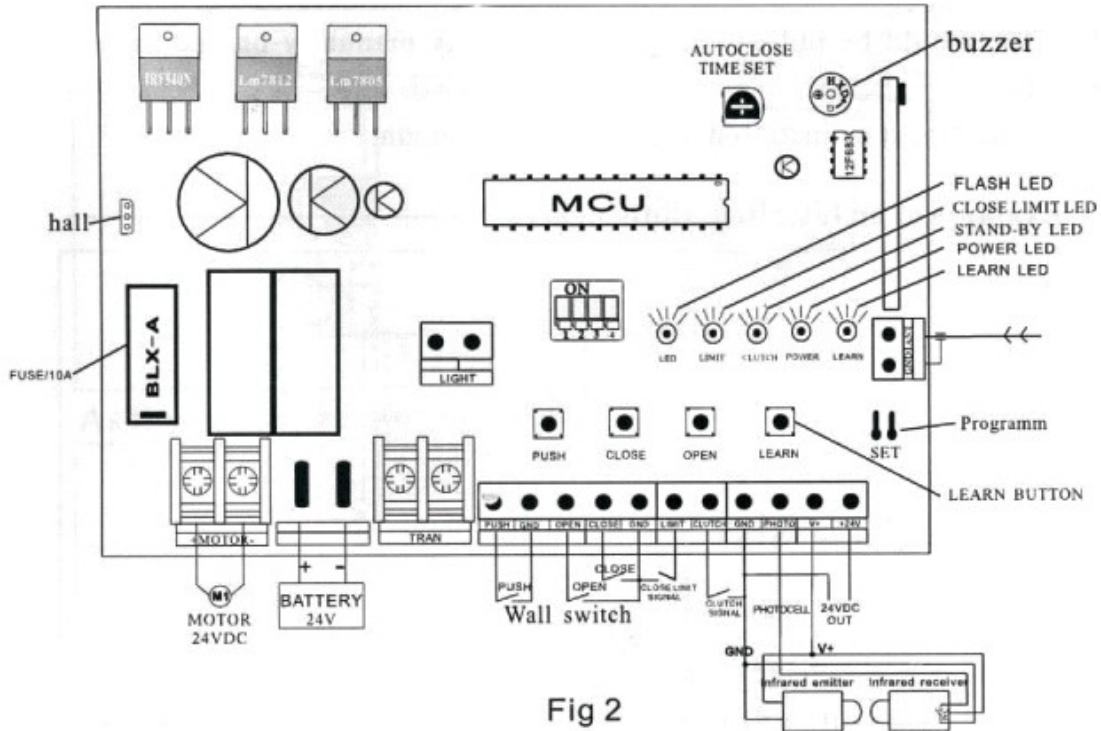

Fig 2

## From Left to Right

- **Hall:** Counter that memorizes the open position of the gate.
- **FUSE:** Check if gate comes in contact with obstacle during motion or after electrical surge.
- **MOTOR:** The motor gets wired into this terminal. It is a DC motor and comes prewired.
- **BATTERY:** 24VDC - Battery provided with connector.
- **LIGHT:** This would power a 24VDC light during the motion of the gate.
- **TRAN:** NOT USED IN THIS APPLICATION.
- **PUSH/GND:** Between the push and ground terminal you would put any entry or exit accessory input. This would be keypads, push buttons, etc. It is a normally open circuit and when the circuit is closed momentarily it makes the gate go into motion. The receiver is prewired in these terminals but more devices can be added in parallel.
- **OPEN/CLOSE/GND:** OPEN and GRD is used for normally open devices you would like to only open the gate from the closed position. CLOSE and GND is used for normally open devices you would like to only close the gate from the open position.

Continue on next Page

# Control Board Overview



**Caution! Do not run 120V AC power direct to the board. This will cause permanent damage to both boards and void your warranty. Caution!**

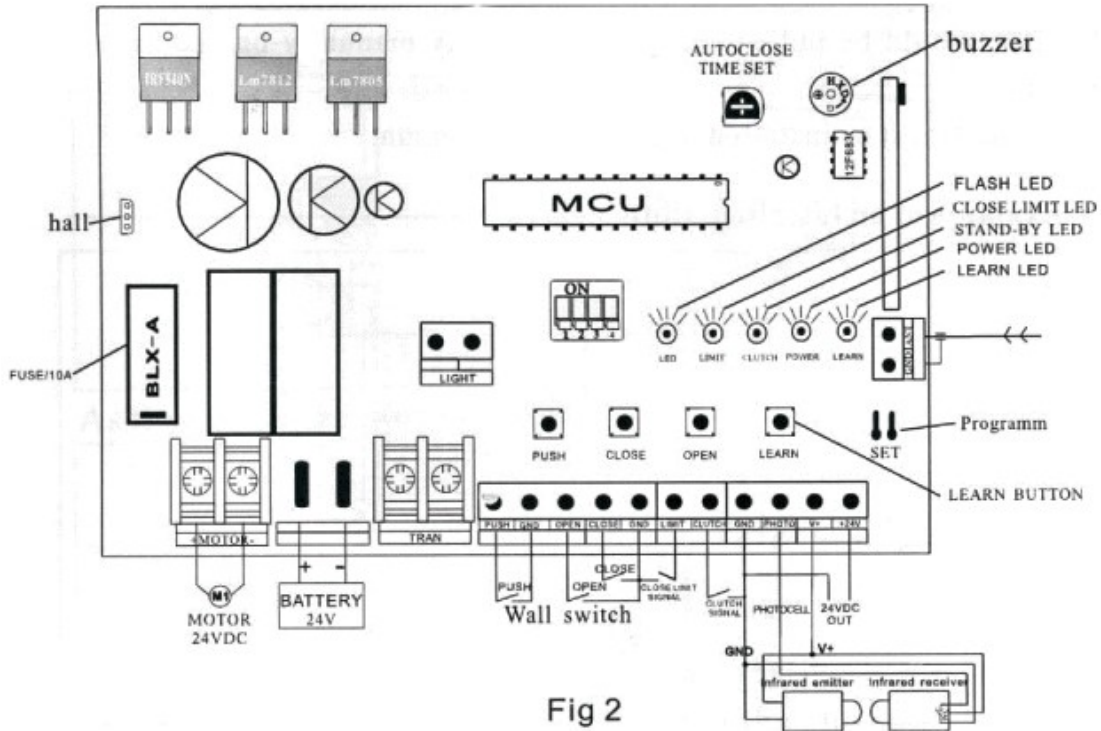

Fig 2

Continued:

- **LIMIT/LH:** Prewired - this is where the limit switch and clutch switch are wired. Do not move.
- **GND/PHOTO:** Photo with the ground would be for safety device inputs like a loop or photo eye. It is a normally closed and when the circuit is broken the gate opener stops. If a safety device is not being used in this terminal the operator must have a jumper ran from this terminal to the GND terminal in order to operate.

**Note: GDN has the negative power for the receiver pre-wired into it. You can add more wires in parallel.**

- **V+:** This is a very low 12VDC output only to be used with a photo cell - not for other accessories.
- **+24V:** This terminal puts out a constant 24V DC current for the receiver.
- **PUSH BUTTON:** Opens and Closes the gate.
- **OPEN BUTTON:** Opens the gate from the closed position.
- **CLOSED BUTTON:** Used for programming and testing.
- **LEARN BUTTON:** Used for programming remotes.

## Warranty / Troubleshooting Notice



If you call in for technical support or warranty support: before any control board or motor will be permitted to be sent in for testing or warranty you will be required to e-mail digital photos to the technician.

This is done in your best interest to save unnecessary shipping expenses and time lost. Many times we can come up with solutions to issues by seeing pictures that relay information that is impossible to relay through a phone conversation.

*Below is an example of a control board picture that we will be looking for:*

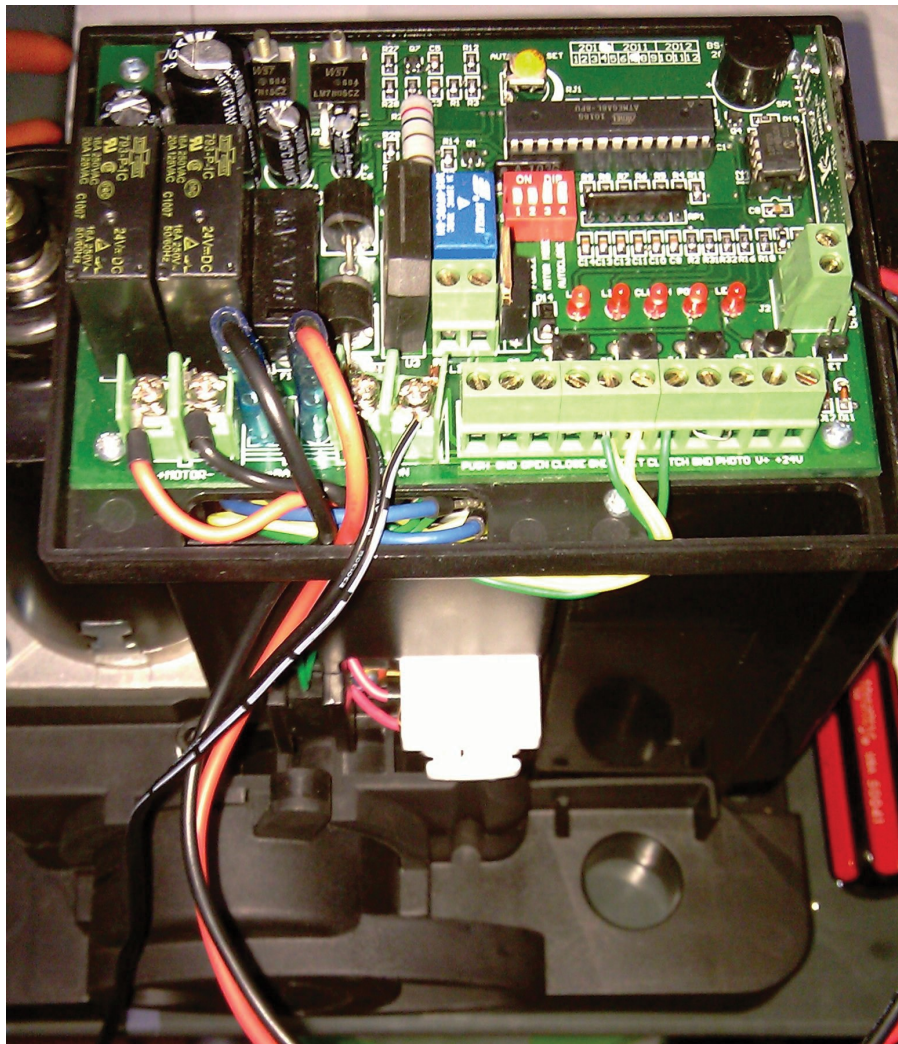

## Accessories Wiring

The manufacturer instructions that come with your accessory should have markings for wires or terminals to connect to the gate opener. Please look for terminals named below in the instructions for the accessory.

### Keypads, Receivers:

**Normally Open (NO) or Input (INP) or Relay of entry device** = *PUSH terminal on gate opener control board.*

**Common (COM) or Ground (GND) or Relay of entry device** = *GND terminal on gate opener control board.*

*NOTE: If the power for the accessory shares a Ground wire/terminal with the relay – Do Not power that accessory off this control board (example: WKP-P keypad). Instead power that device with batteries.*

**24V Power positive (+) or (24V) or (PWR) of entry device** = *+24V terminal of gate opener control board.*

**24V Power Negative (-) or (GND) or (PWR) of entry device** = *GND terminal of gate opener control board.*

### Push Button, Intercoms:

**Normally Open (NO) or Input (INP) or Relay of entry device** = *PUSH terminal of gate opener control board.*

**Common (COM) or Ground (GND) or Relay of entry device** = *GND terminal of gate opener control board.*

**Push buttons do not require power and Intercoms draw too much power to power from the gate opener.**

### Exit Wand/Sensor, Exit Loop Detector, Exit Device:

**Normally Open (NO) or Input (INP) or Relay of exit device** = *OPEN terminal of gate opener control board.*

**Common (COM) or Ground (GND) or Relay of exit device** = *GND terminal of gate opener control board.*

**24V Power positive (+) or (24V) or (PWR) of exit device** = *+24V terminal of gate opener control board.*

**24V Power Negative (-) or (GND) or (PWR) or Shield wire of exit device** = *GND terminal of gate opener control board.*

## Accessories Wiring

### **Photo Eye, Safety Edge, Safety Loop:**

**Normally Closed (NC) of safety device** = *Photo terminal of gate opener control board.*

**Common (COM) or Ground (GND) of safety device** = *GND terminal of gate opener control board.*

**24V Power positive (+) or (24V) or (PWR) of safety device** = *V+ terminal of gate opener control board.*

**24V Power Negative (-) or (GND) or (PWR) of safety device** = *GND terminal of gate opener control board.*

*\*Remove safety jumper from PHOTO terminal if using a safety device.*

### **Magnetic Gate Lock: Magnetic gate locks must have their own power supply and their own relay.**

**Coil of relay for magnetic lock** = *L1-1 Motor lead terminal of gate opener control board.*

**Coil of relay for magnetic lock** = *L1-2 Motor lead terminal of gate opener control board.*

**Connect positive lead of the power supply directly to the positive lead of the mag lock.**

**Connect negative lead of the power supply to the N/C terminal of the relay.**

**Connect the COM terminal of the relay to the negative lead of the mag lock.**